

ALPHA SPOT HPE

★ **Legenda** Diameter 10%-50%: valori del diametro del fascio luminoso corrispondenti al 10% e 50% dell'illuminamento massimo.  
**Key** Diameter 10%-50%: beam diameter for 10% and 50% of maximum illumination.  
**Légende** Diameter 10%-50%: valeurs du diamètre du faisceau lumineux correspondant à 10% et 50% de l'éclairage maximum.  
**Legende** Diameter 10%-50%: Lichtkreis-Durchmesser bei 10% bzw. 50% maximaler Ausleuchtung.  
**Leyenda** Diameter 10%-50%: valores del diámetro del haz luminoso correspondientes al 10% y 50% de la iluminación máxima.

N.B. Con la regolazione della lampada in Hot Spot i valori di illuminamento massimo aumentano di circa il 25%.

**Warning** The maximum lighting values increase by approximately 25% with the lamp regulation on hot spot.

**Attention** Avec le réglage de la lampe en hot spot, les valeurs d'éclairage maximum augmentent d'environ 25%.

**Achtung** Mit der Einstellung der Lampe auf den Hotspot nehmen die maximalen Beleuchtungswerte um ca. 25% zu.

**Atención** Ajustando la lámpara en hot spot, los valores de iluminación máxima aumentan casi un 25%.

Standard (10.4° - 30.2°)

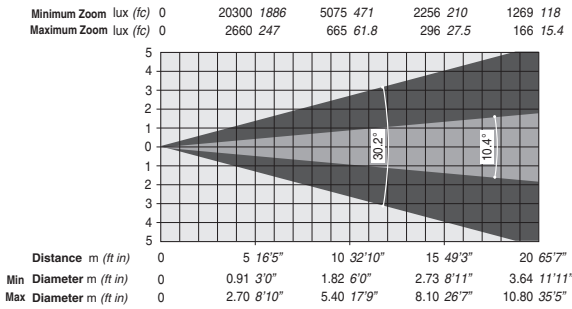

With Extra Lens (11.9° - 38.2°)

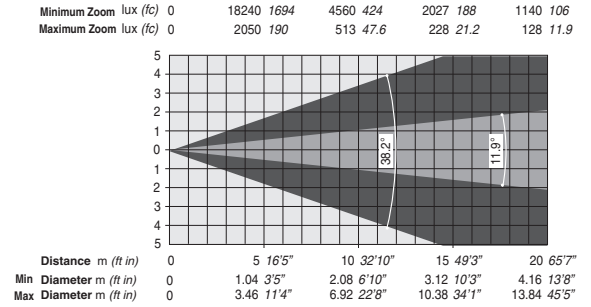

With Holed Frost (10.4° - 30.2°)

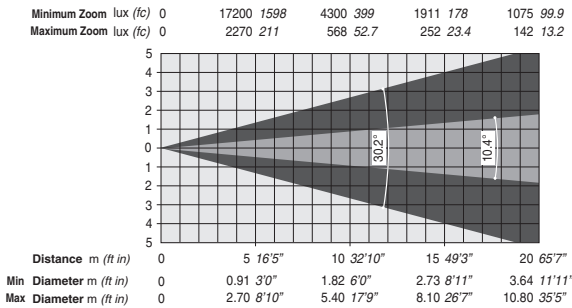

With Extra Lens and Holed Frost (11.9° - 38.2°)

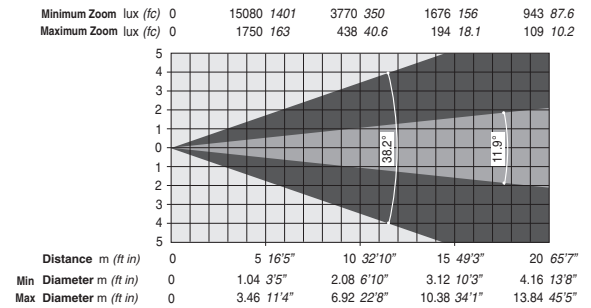

With Light Frost (10.4° - 30.2°)

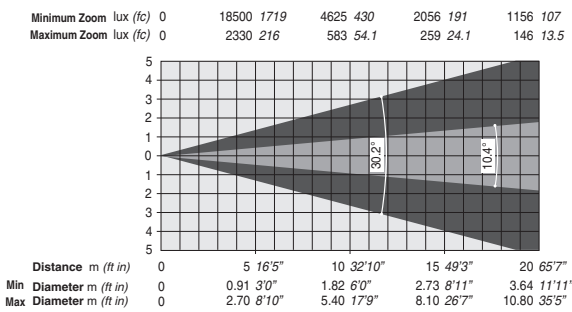

With Extra Lens and Light Frost (11.9° - 38.2°)

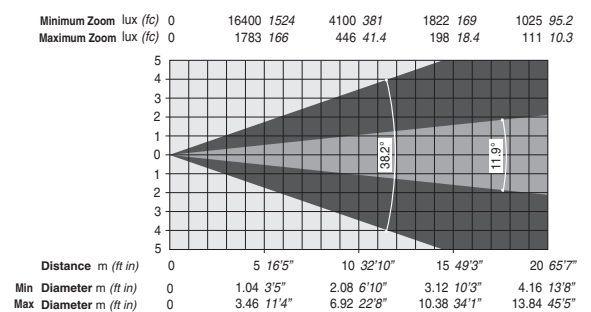

With Heavy Frost (13.9° - 33.2° 10%) ★  
(8.4° - 20.3° 50%) ★

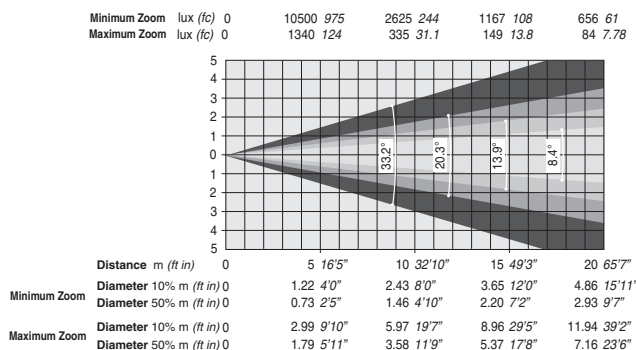

With Extra Lens and Heavy Frost (14.4° - 34.6° 10%) ★  
(8.6° - 21.5° 50%) ★

